

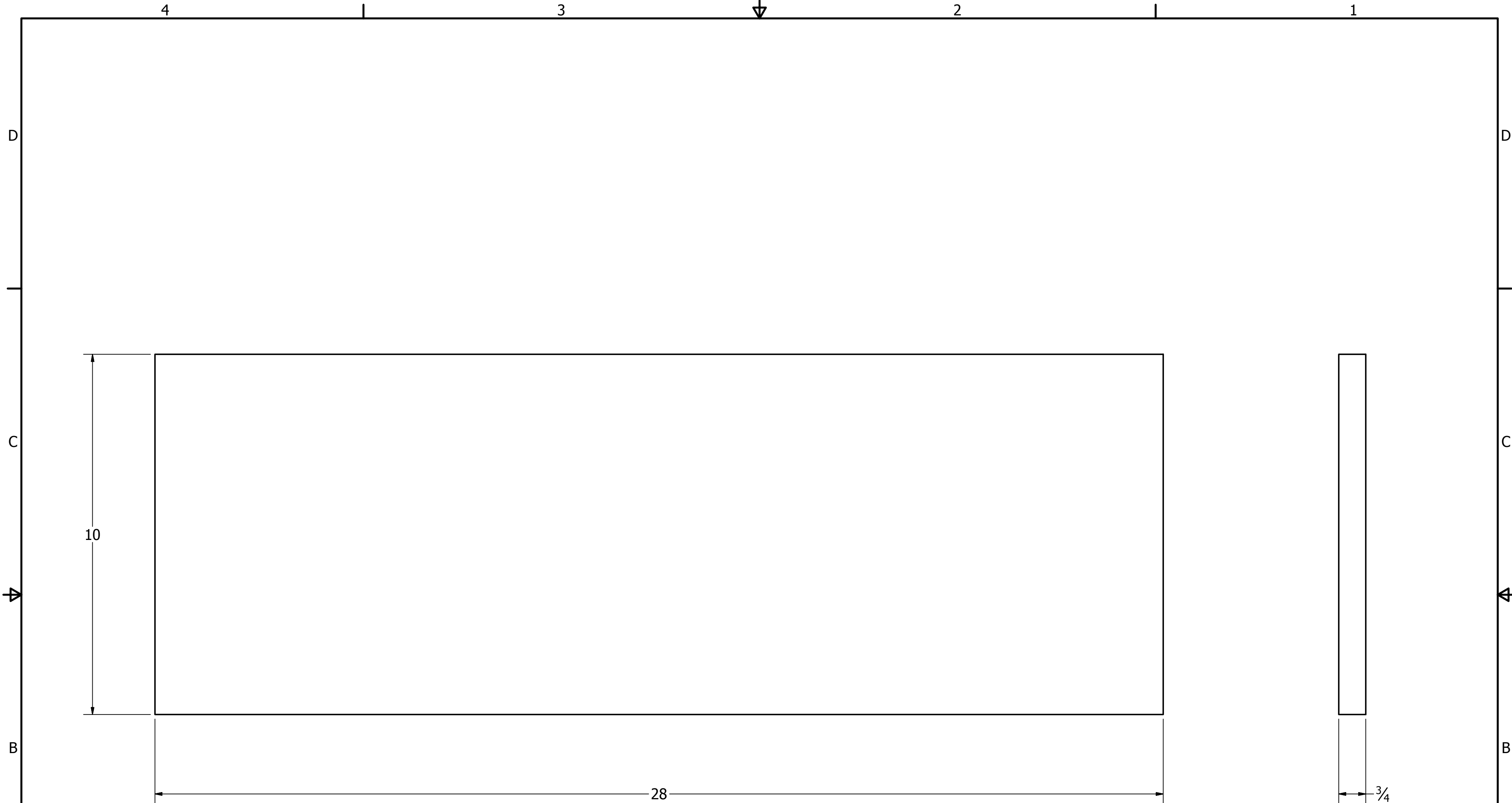



TITLE: THIRD GEN F-BODY SUB BOX V1				
EST WEIGHT 4.005 lbmass	DRAWING NUMBER: TOP PIECE			
THIS DRAWING IS PROPERTY OF AND CONTAINS DESIGN FEATURES AND/OR CONSTRUCTION WHICH ARE PROPRIETARY TO LAYTHROM DESIGNS, DEVISION OF LAYTHROM MEDIA. IT SHALL NOT BE REPRODUCED, COPIED OR DISCLOSED TO ANY THIRD PARTY WITHOUT WRITTEN PERMISSION FROM LAYTHROM MEDIA AND SHALL NOT BE USED IN ANY MANNER DETRIMENTAL TO LAYTHROM MEDIA INTERESTS.	DRAWN BY: M.Adkins		CUST DWG NUMBER	
	CHECKED BY:			REVISION LEVEL: 01
	EST COST:			DWG SIZE C
	STATUS: WIP		SCALE: NTS	



TITLE: THIRD GEN F-BODY SUB BOX V1			
EST WEIGHT 3.793 lbmass	DRAWING NUMBER: BOTTOM PIECE		
THIS DRAWING IS PROPERTY OF AND CONTAINS DESIGN FEATURES AND/OR CONSTRUCTION WHICH ARE PROPRIETARY TO LAYTHROM DESIGNS, DEVISION OF LAYTHROM MEDIA. IT SHALL NOT BE REPRODUCED, COPIED OR DISCLOSED TO ANY THIRD PARTY WITHOUT WRITTEN PERMISSION FROM LAYTHROM MEDIA AND SHALL NOT BE USED IN ANY MANNER DETRIMENTAL TO LAYTHROM MEDIA INTERESTS.	DRAWN BY: M.Adkins		CUST DWG NUMBER
	CHECKED BY:		
	EST COST:		
	STATUS: WIP		SCALE: NTS

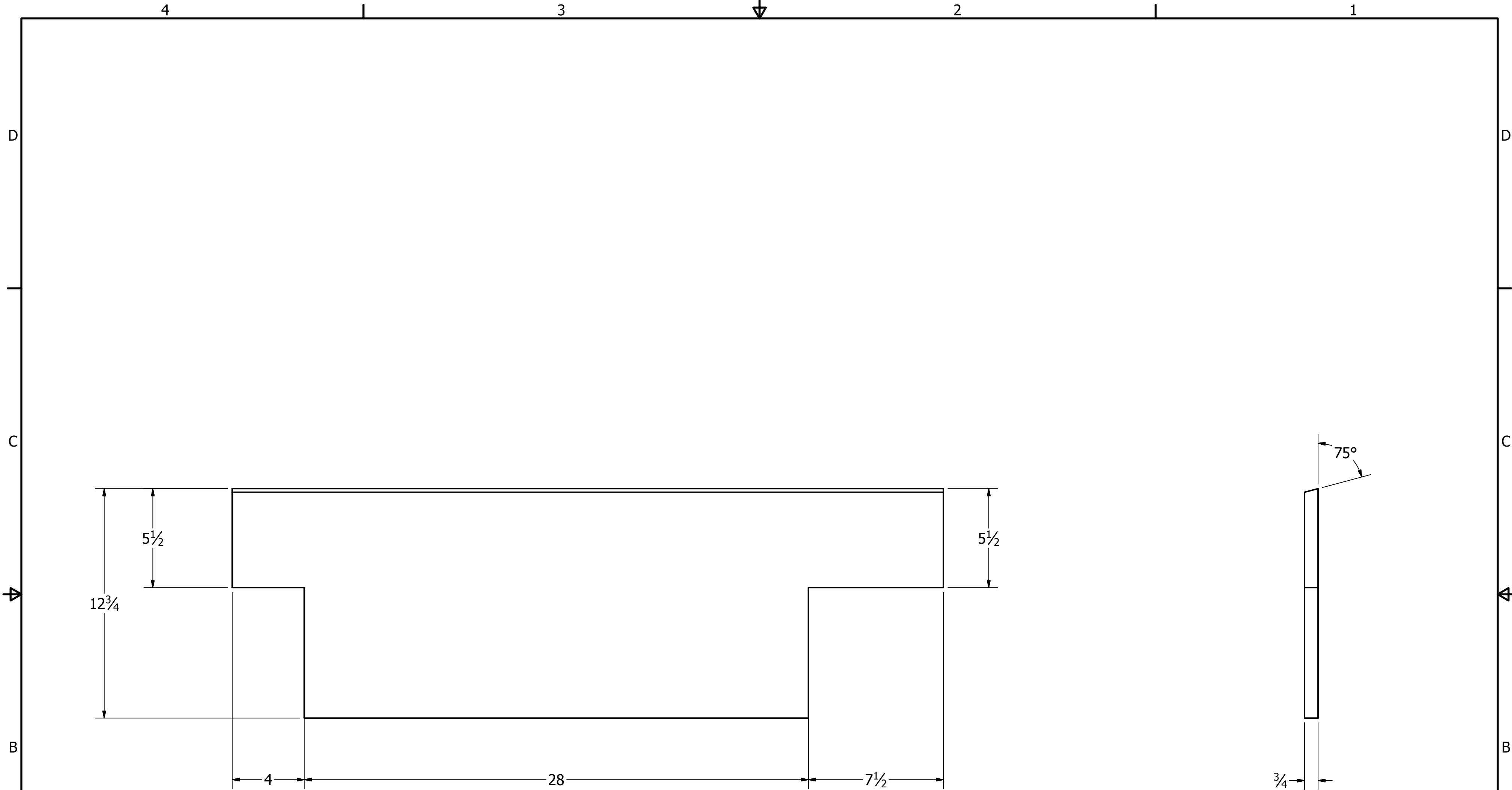

TITLE: THIRD GEN F-BODY SUB BOX V1			
EST WEIGHT 5.640 lbmass		DRAWING NUMBER: FRONT PIECE	
THIS DRAWING IS PROPERTY OF AND CONTAINS DESIGN FEATURES AND/OR CONSTRUCTION WHICH ARE PROPRIETARY TO LAYTHROM DESIGNS, DEVISION OF LAYTHROM MEDIA. IT SHALL NOT BE REPRODUCED, COPIED OR DISCLOSED TO ANY THIRD PARTY WITHOUT WRITTEN PERMISSION FROM LAYTHROM MEDIA AND SHALL NOT BE USED IN ANY MANNER DETRIMENTAL TO LAYTHROM MEDIA INTERESTS.		DRAWN BY: M.ADKINS	
		CUST DWG NUMBER	
		CHECKED BY:	
		EST COST:	
STATUS: WIP		SCALE: NTS	
			
		REVISION LEVEL: 01	
		DWG SIZE C	

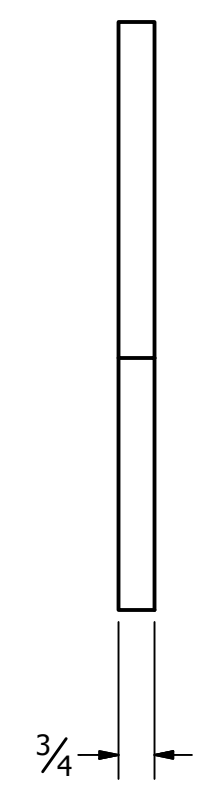
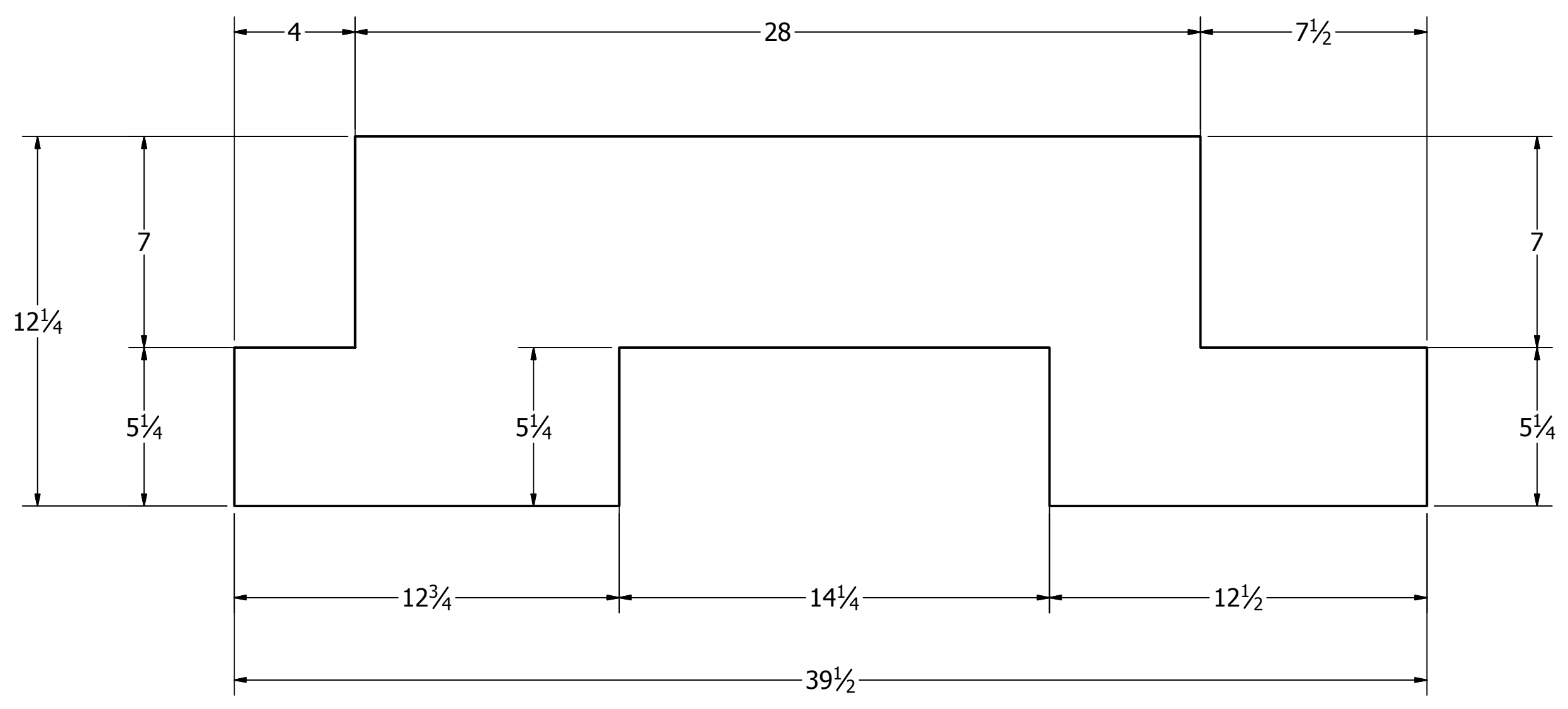

TITLE: THIRD GEN F-BODY SUB BOX V1			
EST WEIGHT 4.451 lbmass	DRAWING NUMBER: BACK PIECE		
THIS DRAWING IS PROPERTY OF AND CONTAINS DESIGN FEATURES AND/OR CONSTRUCTION WHICH ARE PROPRIETARY TO LAYTHROM DESIGNS, DEVISION OF LAYTHROM MEDIA. IT SHALL NOT BE REPRODUCED, COPIED OR DISCLOSED TO ANY THIRD PARTY WITHOUT WRITTEN PERMISSION FROM LAYTHROM MEDIA AND SHALL NOT BE USED IN ANY MANNER DETRIMENTAL TO LAYTHROM MEDIA INTERESTS.	DRAWN BY: M.Adkins		CUST DWG NUMBER N/A
	CHECKED BY:		
	EST COST: \$5.00		
	STATUS: WORK IN PROCESS		SCALE: NTS

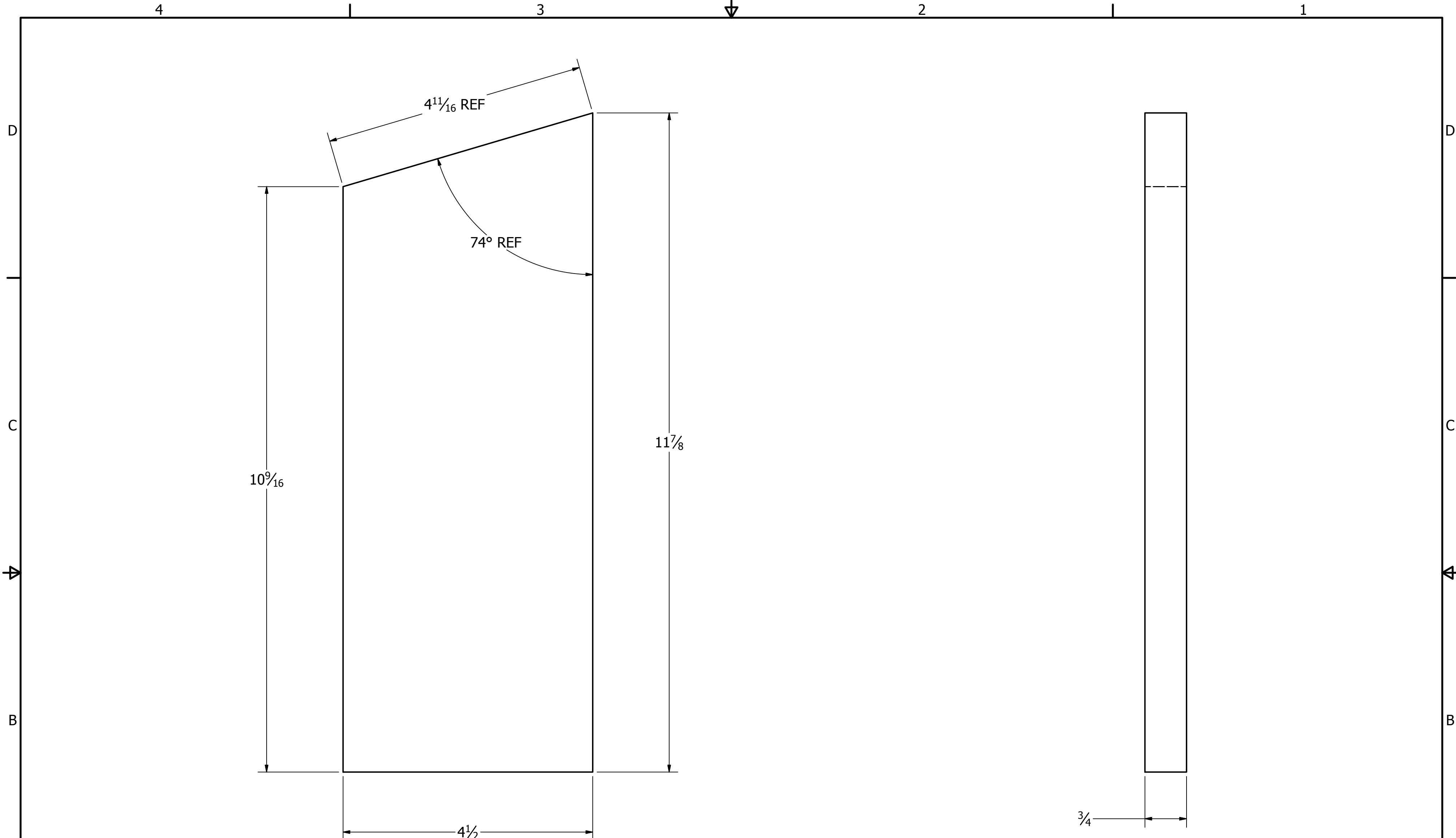

TITLE: THIRD GEN F-BODY SUB BOX V1			
EST WEIGHT 0.683 lbmass	DRAWING NUMBER: F_I PIECE		
THIS DRAWING IS PROPERTY OF AND CONTAINS DESIGN FEATURES AND/OR CONSTRUCTION WHICH ARE PROPRIETARY TO LAYTHROM DESIGNS, DEVISION OF LAYTHROM MEDIA. IT SHALL NOT BE REPRODUCED, COPIED OR DISCLOSED TO ANY THIRD PARTY WITHOUT WRITTEN PERMISSION FROM LAYTHROM MEDIA AND SHALL NOT BE USED IN ANY MANNER DETRIMENTAL TO LAYTHROM MEDIA INTERESTS.	DRAWN BY: M.Adkins		CUST DWG NUMBER
	CHECKED BY:		
	EST COST:		
	STATUS: WIP		SCALE: NTS

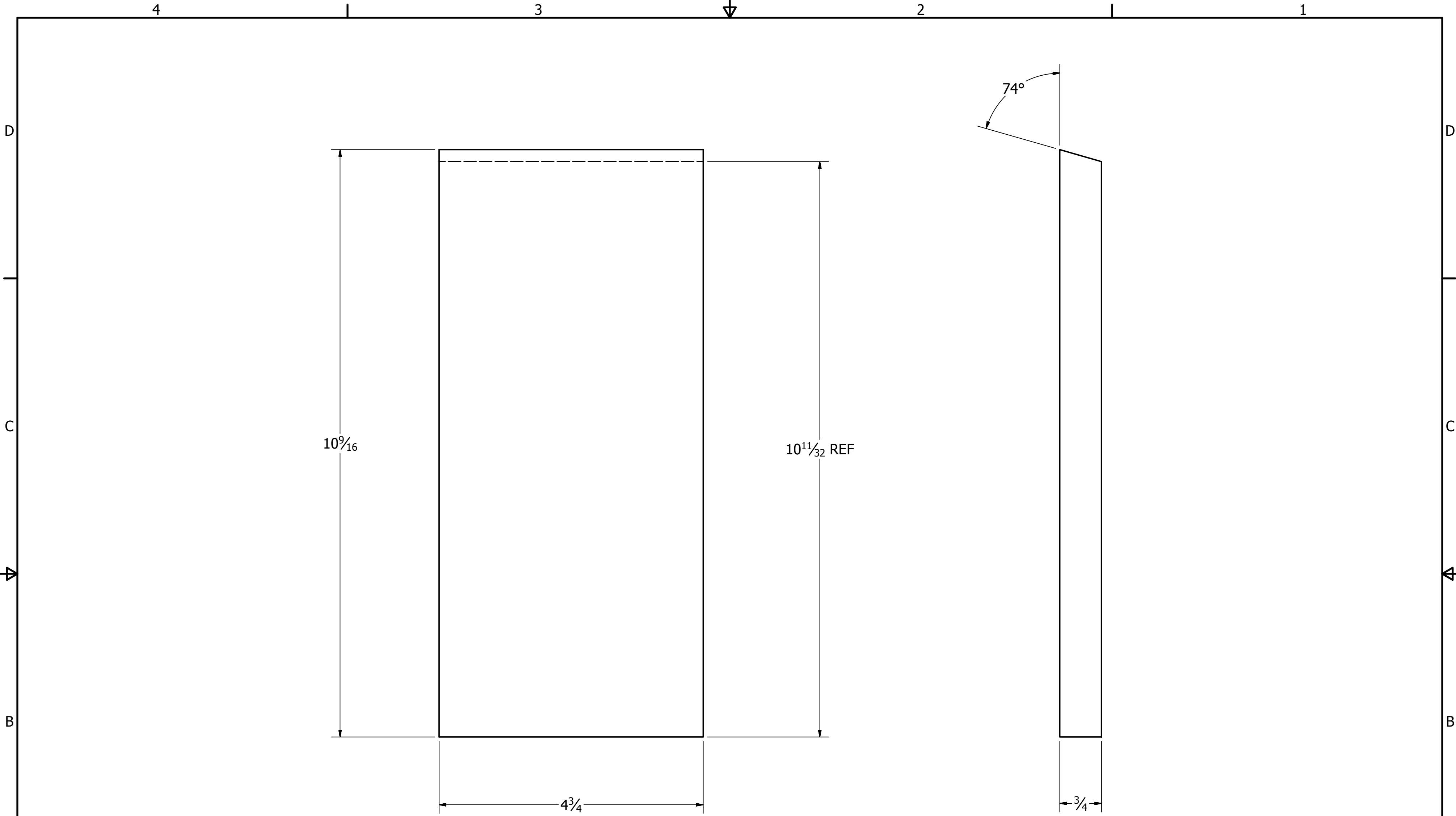

TITLE: THIRD GEN F-BODY SUB BOX V1			
EST WEIGHT 0.673 lbmass	DRAWING NUMBER: E PIECE		
THIS DRAWING IS PROPERTY OF AND CONTAINS DESIGN FEATURES AND/OR CONSTRUCTION WHICH ARE PROPRIETARY TO LAYTHROM DESIGNS, DEVISION OF LAYTHROM MEDIA. IT SHALL NOT BE REPRODUCED, COPIED OR DISCLOSED TO ANY THIRD PARTY WITHOUT WRITTEN PERMISSION FROM LAYTHROM MEDIA AND SHALL NOT BE USED IN ANY MANNER DETRIMENTAL TO LAYTHROM MEDIA INTERESTS.	DRAWN BY: M.Adkins		CUST DWG NUMBER
	CHECKED BY:		
	EST COST:		
	STATUS: WIP		SCALE: NTS

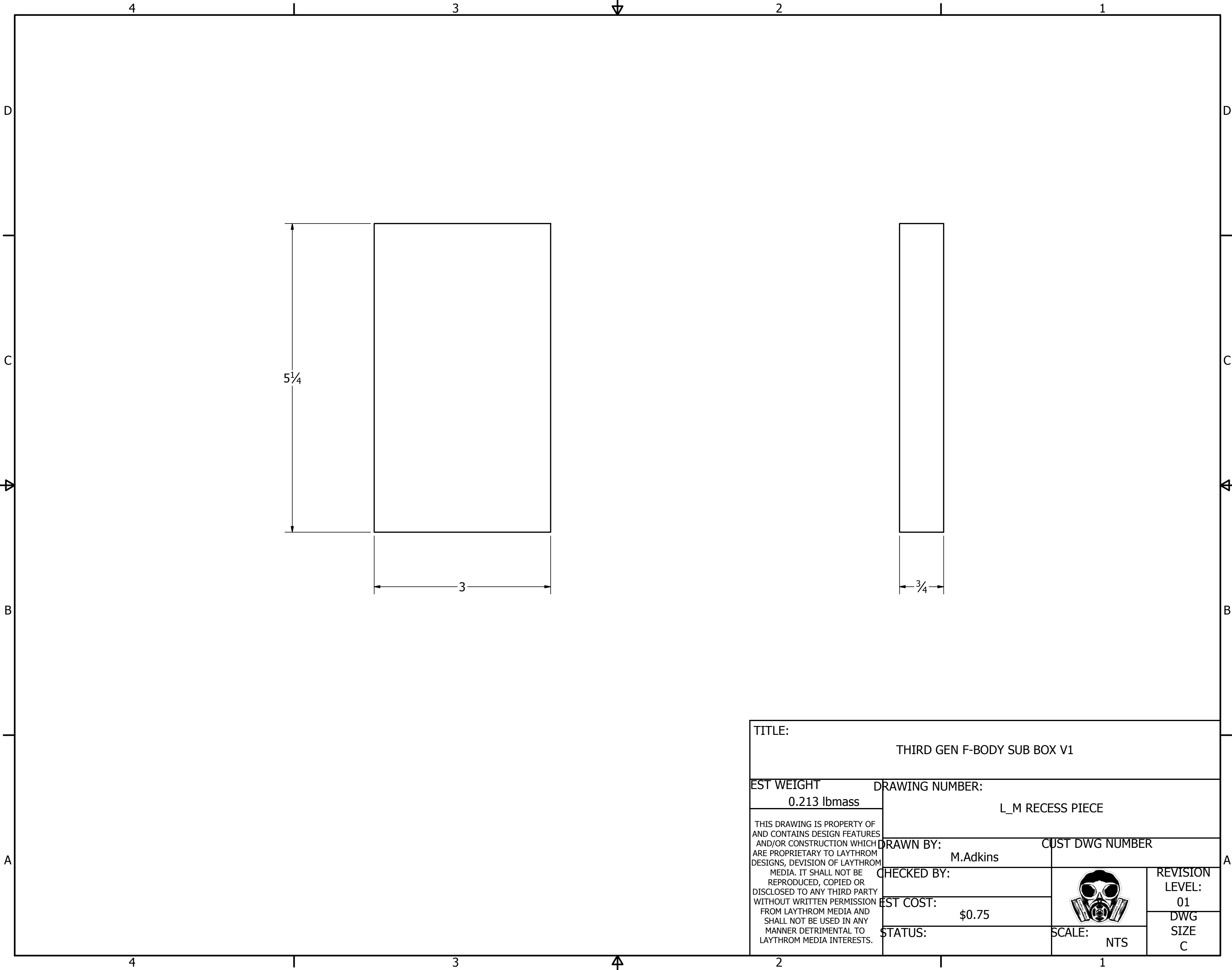

TITLE: THIRD GEN F-BODY SUB BOX V1			
EST WEIGHT 0.213 lbmass	DRAWING NUMBER: L_M RECESS PIECE		
THIS DRAWING IS PROPERTY OF AND CONTAINS DESIGN FEATURES AND/OR CONSTRUCTION WHICH ARE PROPRIETARY TO LAYTHROM DESIGNS, DEVISION OF LAYTHROM MEDIA. IT SHALL NOT BE REPRODUCED, COPIED OR DISCLOSED TO ANY THIRD PARTY WITHOUT WRITTEN PERMISSION FROM LAYTHROM MEDIA AND SHALL NOT BE USED IN ANY MANNER DETRIMENTAL TO LAYTHROM MEDIA INTERESTS.	DRAWN BY: M.Adkins		CUST DWG NUMBER
	CHECKED BY:		
	EST COST: \$0.75		
	STATUS:		SCALE: NTS

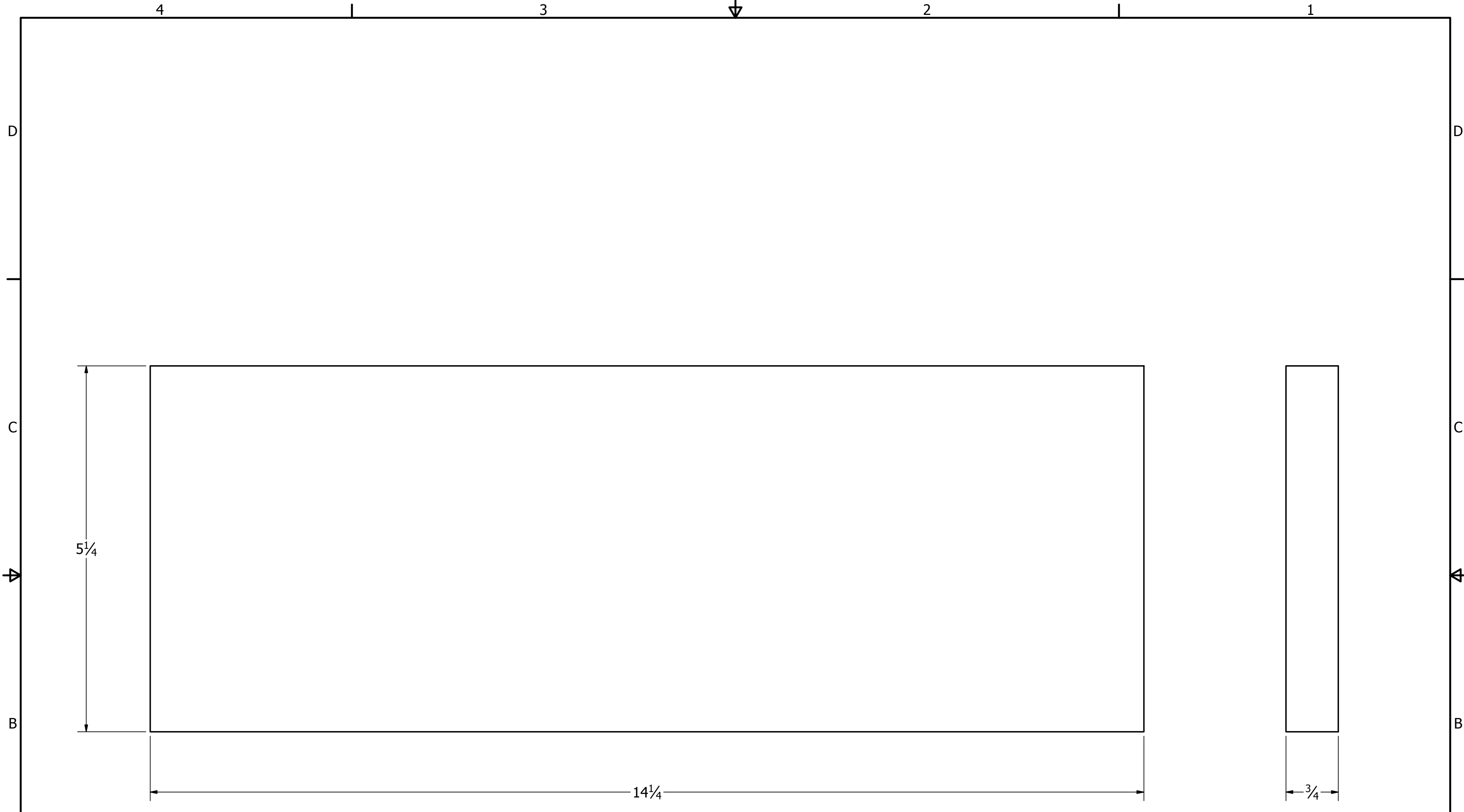

TITLE: THIRD GEN F-BODY SUB BOX V1			
EST WEIGHT 1.014 lbmass	DRAWING NUMBER: K RECESS PIECE		
THIS DRAWING IS PROPERTY OF AND CONTAINS DESIGN FEATURES AND/OR CONSTRUCTION WHICH ARE PROPRIETARY TO LAYTHROM DESIGNS, DEVISION OF LAYTHROM MEDIA. IT SHALL NOT BE REPRODUCED, COPIED OR DISCLOSED TO ANY THIRD PARTY WITHOUT WRITTEN PERMISSION FROM LAYTHROM MEDIA AND SHALL NOT BE USED IN ANY MANNER DETRIMENTAL TO LAYTHROM MEDIA INTERESTS.	DRAWN BY: M.Adkins		CUST DWG NUMBER
	CHECKED BY:		
	EST COST: \$0.75		
	STATUS: WORK IN PROCESS		SCALE: NTS

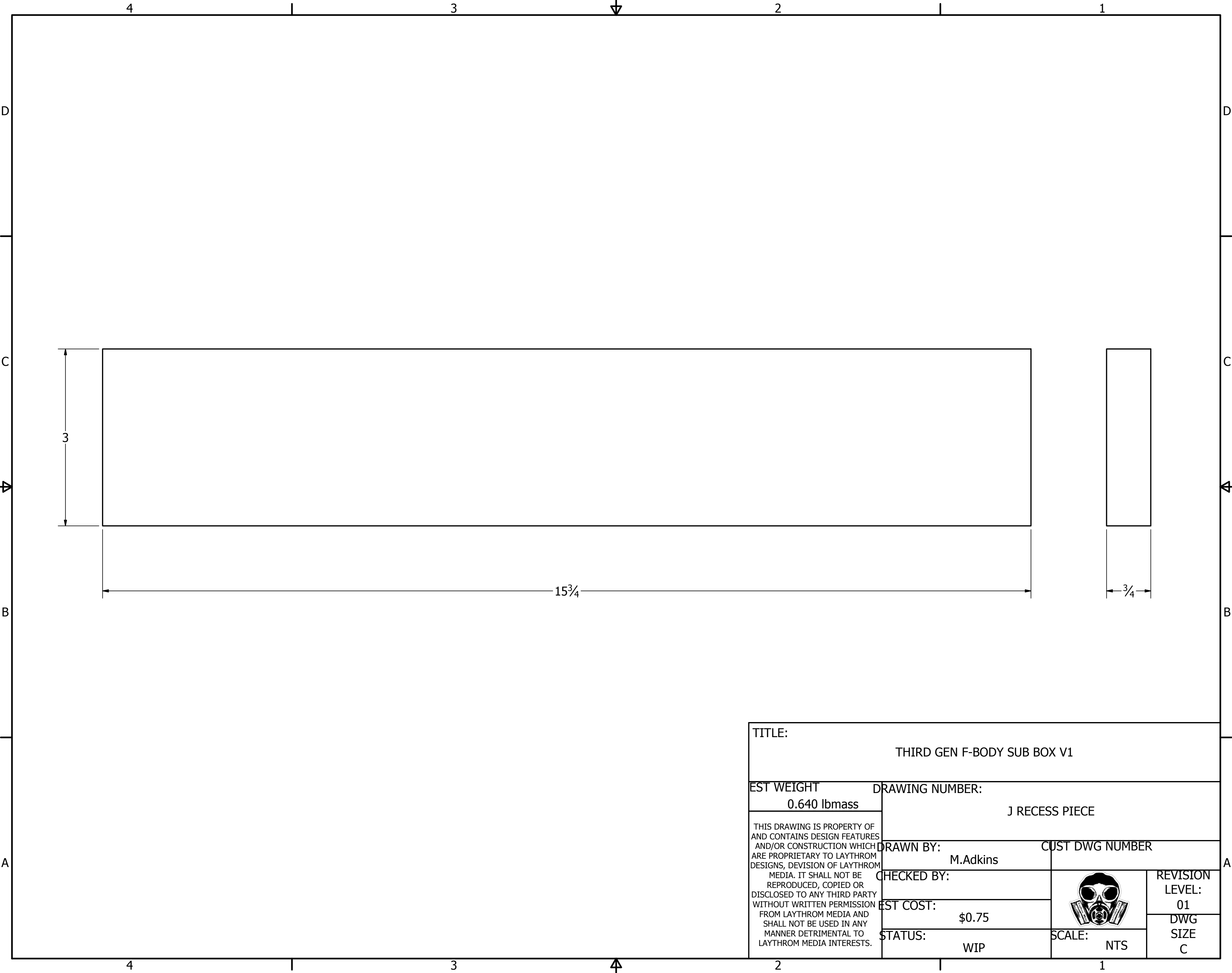

TITLE:				
THIRD GEN F-BODY SUB BOX V1				
EST WEIGHT	DRAWING NUMBER:			
0.640 lbmass	J RECESS PIECE			
<small>THIS DRAWING IS PROPERTY OF AND CONTAINS DESIGN FEATURES AND/OR CONSTRUCTION WHICH ARE PROPRIETARY TO LAYTHROM DESIGNS, DEVISION OF LAYTHROM MEDIA. IT SHALL NOT BE REPRODUCED, COPIED OR DISCLOSED TO ANY THIRD PARTY WITHOUT WRITTEN PERMISSION FROM LAYTHROM MEDIA AND SHALL NOT BE USED IN ANY MANNER DETRIMENTAL TO LAYTHROM MEDIA INTERESTS.</small>	DRAWN BY:		CUST DWG NUMBER	
	M.Adkins			
	CHECKED BY:			REVISION LEVEL:
	EST COST:			01
	\$0.75			DWG SIZE
STATUS:		SCALE:	C	
WIP		NTS		

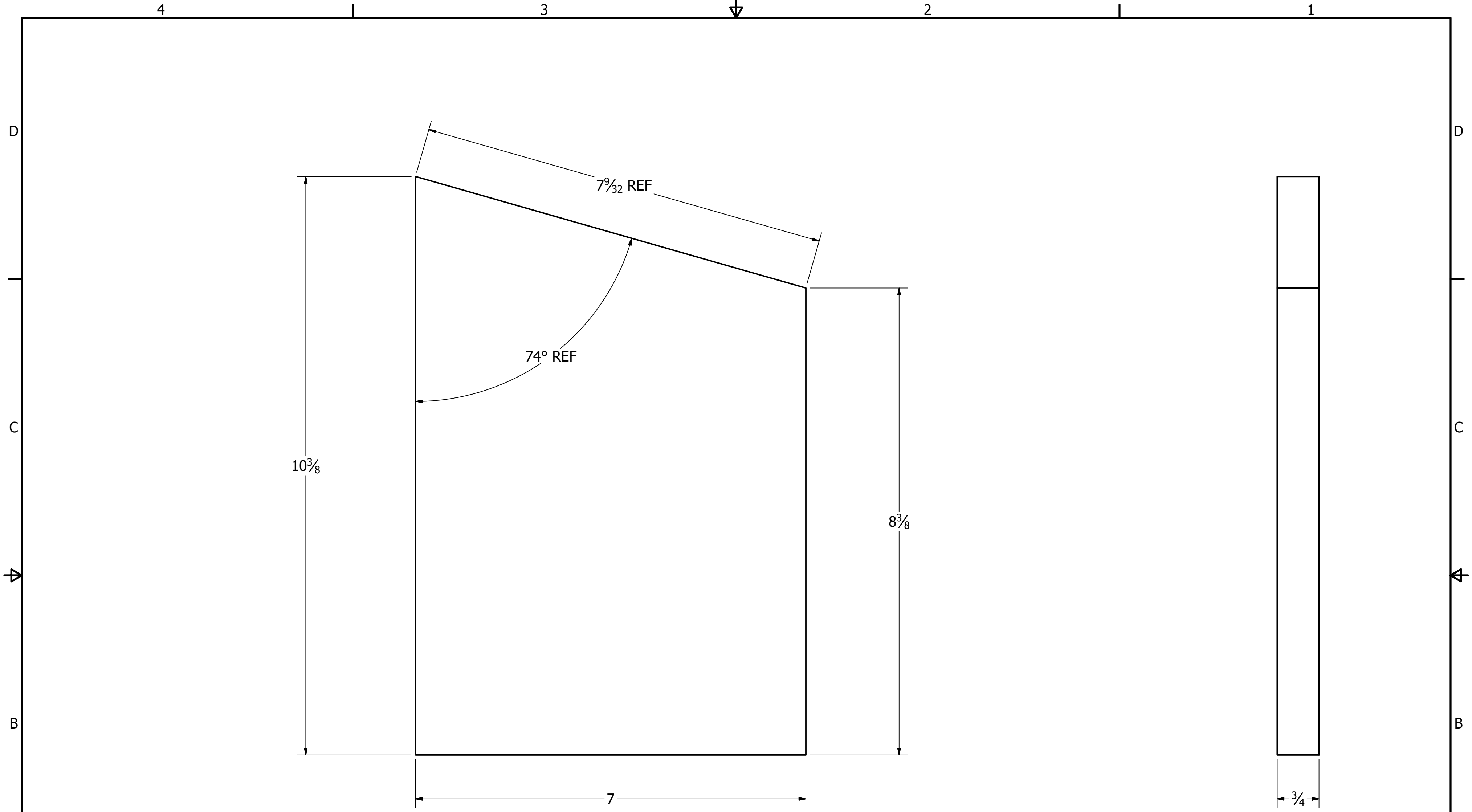

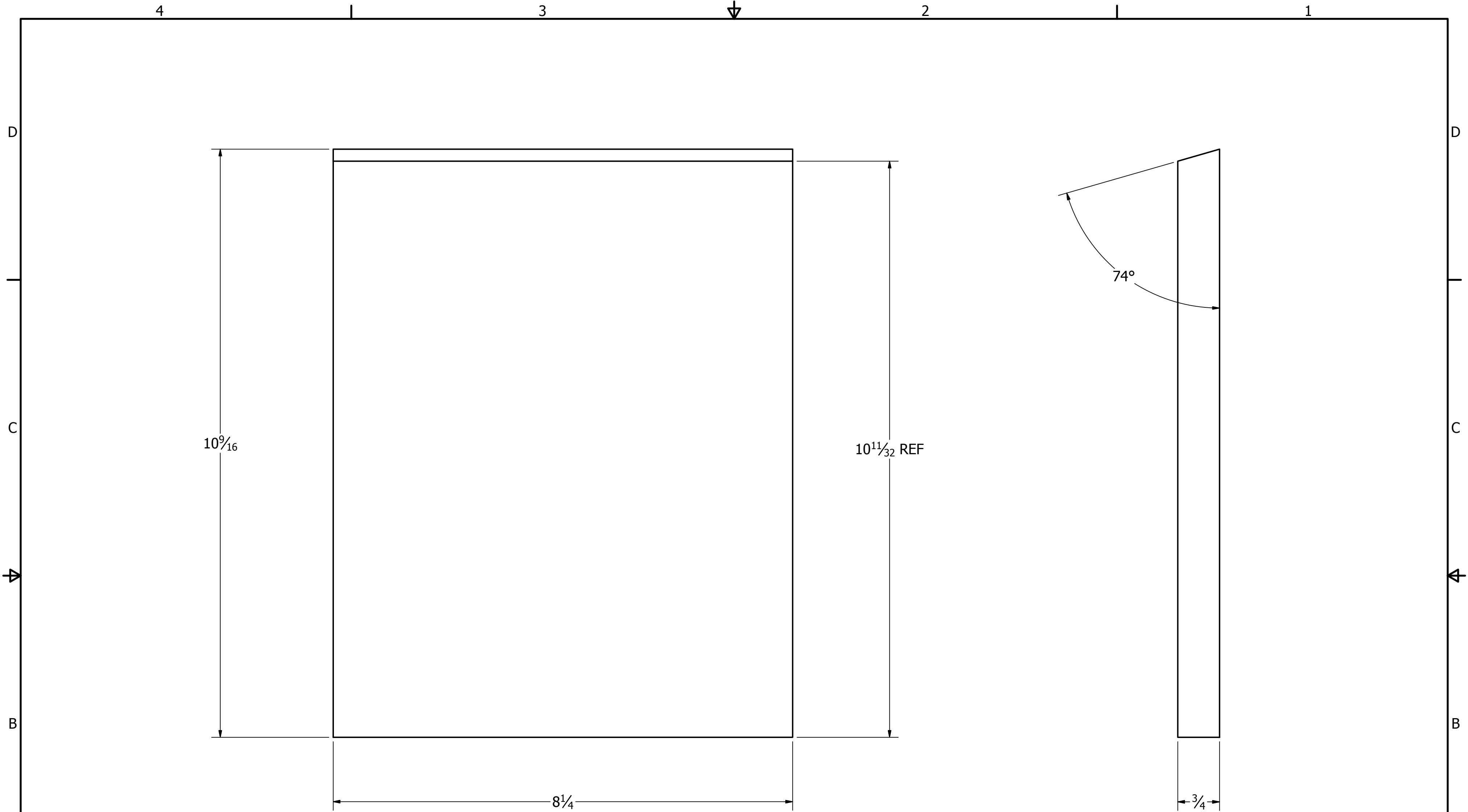

TITLE: THIRD GEN F-BODY SUB BOX V1			
EST WEIGHT 0.889 lbmass	DRAWING NUMBER: D_G		
THIS DRAWING IS PROPERTY OF AND CONTAINS DESIGN FEATURES AND/OR CONSTRUCTION WHICH ARE PROPRIETARY TO LAYTHROM DESIGNS, DEVISION OF LAYTHROM MEDIA. IT SHALL NOT BE REPRODUCED, COPIED OR DISCLOSED TO ANY THIRD PARTY WITHOUT WRITTEN PERMISSION FROM LAYTHROM MEDIA AND SHALL NOT BE USED IN ANY MANNER DETRIMENTAL TO LAYTHROM MEDIA INTERESTS.	DRAWN BY: M.Adkins		CUST DWG NUMBER
	CHECKED BY:		
	EST COST: \$1.00		
	STATUS: WORK IN PROCESS		SCALE: NTS

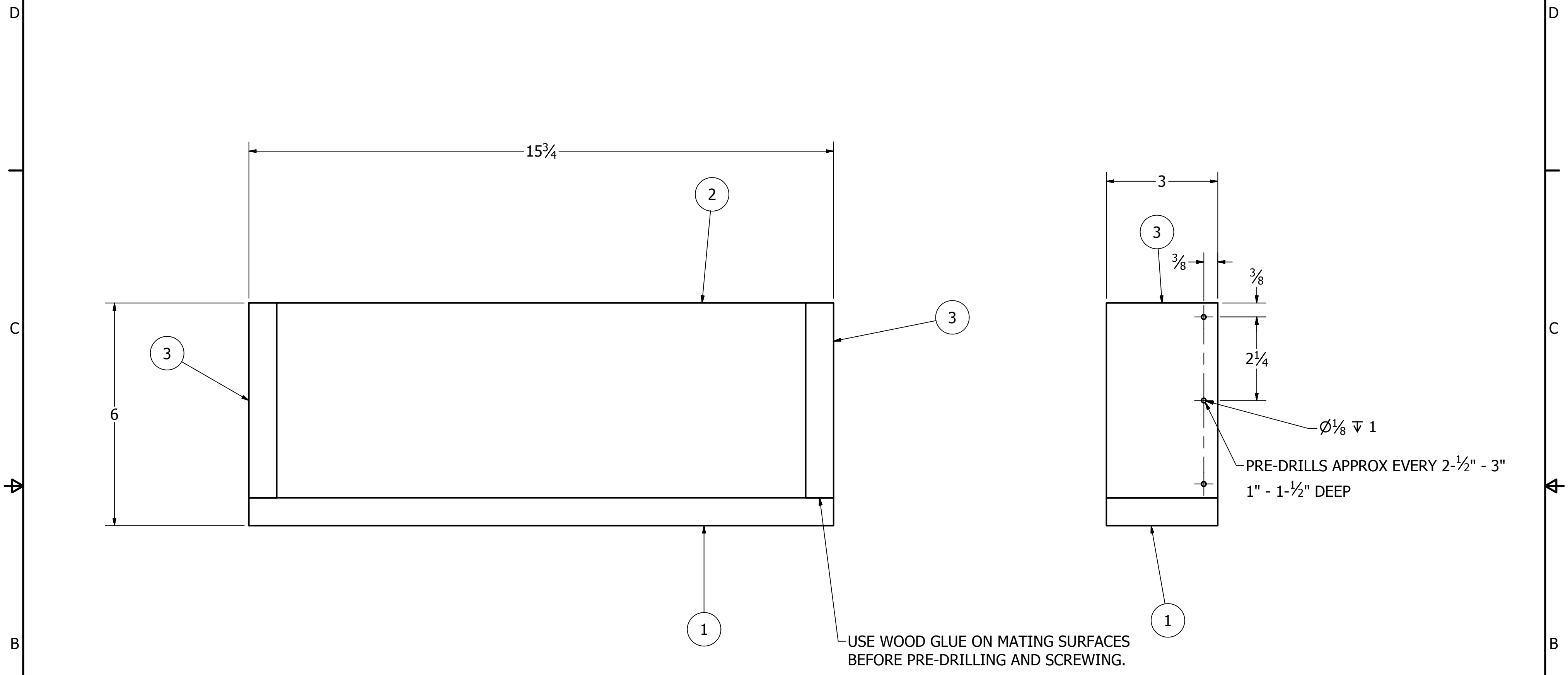

TITLE:				
THIRD GEN F-BODY SUB BOX V1				
EST WEIGHT	DRAWING NUMBER:			
1.169 lbmass	H PIECE			
<small>THIS DRAWING IS PROPERTY OF AND CONTAINS DESIGN FEATURES AND/OR CONSTRUCTION WHICH ARE PROPRIETARY TO LAYTHROM DESIGNS, DEVISION OF LAYTHROM MEDIA. IT SHALL NOT BE REPRODUCED, COPIED OR DISCLOSED TO ANY THIRD PARTY WITHOUT WRITTEN PERMISSION FROM LAYTHROM MEDIA AND SHALL NOT BE USED IN ANY MANNER DETRIMENTAL TO LAYTHROM MEDIA INTERESTS.</small>	DRAWN BY:		CUST DWG NUMBER	
	M.Adkins			
	CHECKED BY:			REVISION LEVEL:
	EST COST:			01
STATUS:		SCALE:	DWG SIZE	
WIP		NTS	C	

PARTS LIST			
ITEM	QTY	PART NUMBER	DESCRIPTION
1	1	J RECESS PIECE	THIRD GEN F-BODY SUB BOX V1
2	1	K RECESS PIECE	THIRD GEN F-BODY SUB BOX V1
3	2	L_M RECESS PIECE	THIRD GEN F-BODY SUB BOX V1



TITLE: THIRD GEN F-BODY SUB BOX V1			
EST WEIGHT 2.077 lbmass	DRAWING NUMBER: recess		
THIS DRAWING IS PROPERTY OF AND CONTAINS DESIGN FEATURES AND/OR CONSTRUCTION WHICH ARE PROPRIETARY TO LAYTHROM DESIGNS, DEVISION OF LAYTHROM MEDIA. IT SHALL NOT BE REPRODUCED, COPIED OR DISCLOSED TO ANY THIRD PARTY WITHOUT WRITTEN PERMISSION FROM LAYTHROM MEDIA AND SHALL NOT BE USED IN ANY MANNER DETRIMENTAL TO LAYTHROM MEDIA INTERESTS.	DRAWN BY: M.Adkins		CUST DWG NUMBER
	CHECKED BY:		
	EST COST: \$3.50		
	STATUS: WIP		SCALE: NTS

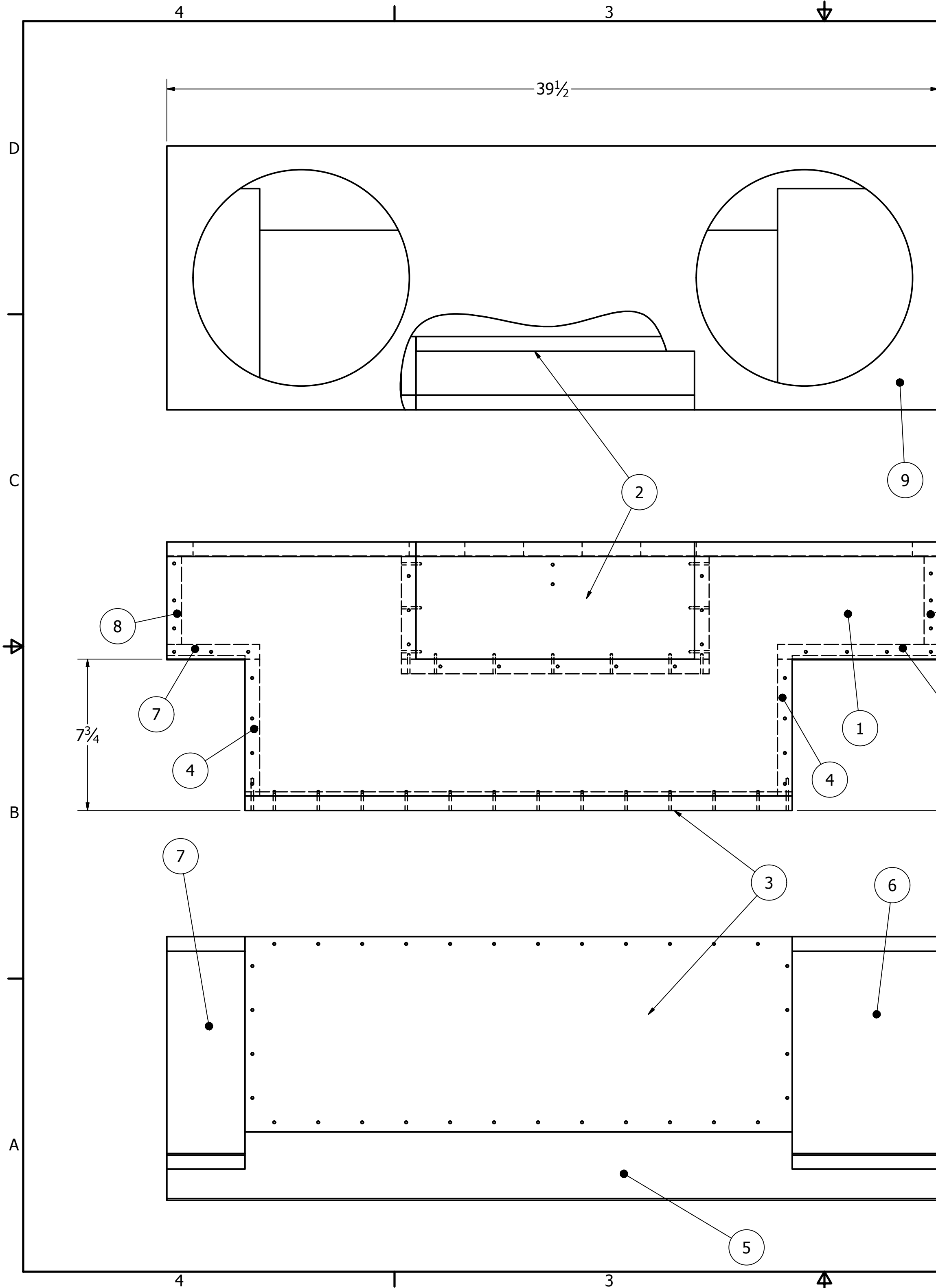

PARTS LIST			
ITEM	QTY	PART NUMBER	DESCRIPTION
1	1	BACK PIECE	THIRD GEN F-BODY BOX
2	1	recess	THIRD GEN F-BODY SUB BOX V1
3	1	BOTTOM PIECE	THIRD GEN F-BODY SUB BOX V1
4	2	D_G	THIRD GEN F-BODY SUB BOX V1
5	1	FRONT PIECE	THIRD GEN F-BODY SUB BOX V1
6	1	H PIECE	THIRD GEN F-BODY SUB BOX V1
7	1	E PIECE	THIRD GEN F-BODY SUB BOX V1
8	2	F_I PIECE	THIRD GEN F-BODY SUB BOX V1
9	1	TOP PIECE	THIRD GEN F-BODY SUB BOX V1

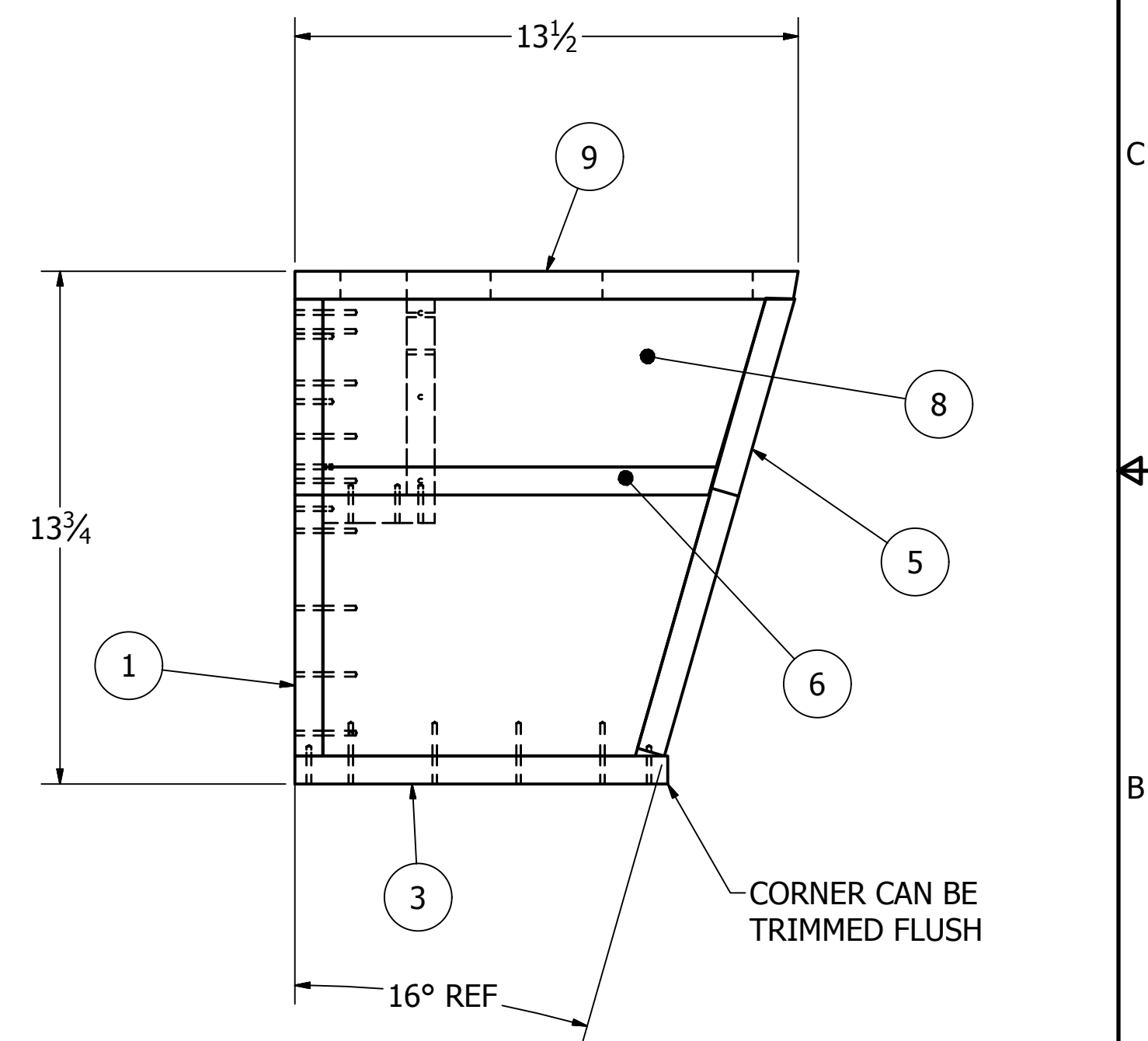

TITLE: THIRD GEN F-BODY SUB BOX V1			
EST WEIGHT 24.743 lbmass	DRAWING NUMBER: BOX ASSEMBLY		
<small>THIS DRAWING IS PROPERTY OF AND CONTAINS DESIGN FEATURES AND/OR CONSTRUCTION WHICH ARE PROPRIETARY TO LAYTHROM DESIGNS, DIVISION OF LAYTHROM MEDIA. IT SHALL NOT BE REPRODUCED, COPIED OR DISCLOSED TO ANY THIRD PARTY WITHOUT WRITTEN PERMISSION FROM LAYTHROM MEDIA AND SHALL NOT BE USED IN ANY MANNER DETRIMENTAL TO LAYTHROM MEDIA INTERESTS.</small>	DRAWN BY: M.Adkins		CUST DWG NUMBER
	CHECKED BY:		
	EST COST:		
	STATUS: WIP		SCALE: NTS